













Part Number	Description	Image	Price per Unit (USD)
Q-100-0112	Pallet Tugger Cart 1260 x 1260 mm		1 850 USD
Q-100-7684	Pallet Tugger Cart 1260 x 1260 mm		1 970 USD
Q-100-2039	Roller Rail Cart 1260 x 840 mm		1 390 USD
Q-100-7022	Flow Shelf Cart 1400 x 840 mm		1 950 USD
Q-100-4747	Flow Rack 1260 x 2450 mm		2 150 USD
Q-100-1621	Flow Shelf Cart 1610 x 840 mm		1 750 USD
Q-100-8528	Roller Rail Cart 2100 x 980 mm		2 250 USD
Q-100-6672	Tool Kit Cart 630 x 770 mm		1 390 USD
Q-100-8507	Flow Shelf Cart 770 x 490 mm		850 USD
Q-100-8512	Flat Shelf Cart 1750 x 700 mm		2 300 USD
Q-007-1424	Shelf Tugger Cart 840 x 1680 mm		2 400 USD
Q-100-8510	Extendable Shelf Cart 1750 x 1330 mm		3 750 USD

Part Number	Description	Image	Price per Unit (USD)
Q-100-6488	Pallet AGV 910 x 840 mm		43 000 USD 29 000 USD
Q-100-6510	Towing Pallet AGV 1260 x 1260 mm		43 000 USD 29 000 USD

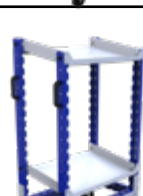

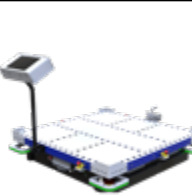

* AGV prices valid until June 30th, 2025

** AGV offer includes additional battery, all accessories needed for installation like heavy duty tape, RFID tags, charger and tablet.
Price also includes installation and training during 2 days onsite by FlexQube technician.

Part Number	Description	Image	Price per Unit (USD)
Q-004-1363	Swivel Caster Grey (125 mm)		20 USD
Q-004-1364	Swivel Caster Grey (125 mm)		22 USD
Q-004-1365	Fixed Caster Grey (125 mm)		18 USD
Q-004-1351	Polyamide with Brake (200 mm)		56 USD
Q-044-1352	Polyamide without Brake (200 mm)		54 USD
Q-004-1354	Polyamide Fixed (200 mm)		52 USD
Q-004-1210	Polyurethane Wheel (200 mm Swivel B)		80 USD
Q-004-1211	Swivel Polyurethane (200 mm)		92 USD
Q-004-1212	Fixed Polyurethane (200 mm)		88 USD
Q-004-1136	Polyurethane Wheel (200 mm x 50 mm)		65 USD
Q-017-0160	Tow Bar (560 mm - 40 mm Lip)		195 USD
Q-017-0132	Tow Bar (560 mm - 28 mm Lip)		195 USD
Q-017-1010	Towing Lip (28 mm)		20 USD
Q-017-1013	Towing Lip (40 mm)		20 USD
Q-017-0067	Spring Loaded Tow Hitch		125 USD
Q-004-0217	Floor Brake Blicke (200 mm)		135 USD
Q-004-1359	Floor Brake LTL (200 mm)		56 USD

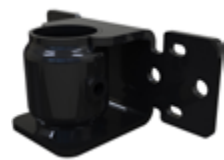
SPARE PARTS

Standard Carts

Part Number	Description	Image	Price per Unit (USD)
Q-005-0227	Angled Corner Plate		24 USD
Q-015-0111	Handlebar Attachment		40 USD
Q-015-0122	Handlebar / Floorbrake Attachment		45 USD
Q-015-0032	Tube for Handlebar		115 USD
Q-015-1037	Handlebar M8 (210 mm)		42 USD

AGV SPARE PARTS

Part Number	Description	Image	Price per Unit (USD)
Q-040-0371	E-Stop Module M12		205 USD
Q-043-0697	Hokuyo Laser Scanner M23 - 1500 mm		2 100 USD
Q-040-0376	AGV Brain 3.0		8 500 USD
Q-040-0368	Corner Module for Scanner		675 USD
Q-040-0412	Higo battery System Upgrade Kit		4 630 USD
Q-040-0417	Tablet S7 FE Holder With Hinges		1 820 USD
Q-043-0360	Flex Button FlexQube Branded		100 USD
Q-042-1031	Line Tape Red (Heavy Duty - 30 m)		90 USD
Q-042-1032	Line Tape Green (Heavy Duty - 30 m)		90 USD
Q-042-0540	Line Tape Blue (Heavy Duty - 30 m)		90 USD

For questions or inquiries, contact us on our website at www.flexqube.com/contact/ or call us at +1 (864) 749-1021.